

NOTE:

1. DIMENSIONS ACCOMMODATE ANSI Z245.60-2008 TYPE B CONTAINERS (DOMESTIC 2-BAR CARTS), BUT MAY VARY DUE TO CONTAINER SPECIFICATIONS OR APPLICATIONS.
2. ALL DIMENSIONS ARE APPROXIMATE.
3. FOR BOLT-ON APPLICATIONS USE MOUNTING PLATE KIT 2000-1136 OR 2000-1112.
4. PART NUMBERS: 1999-0180 - MBTL 180

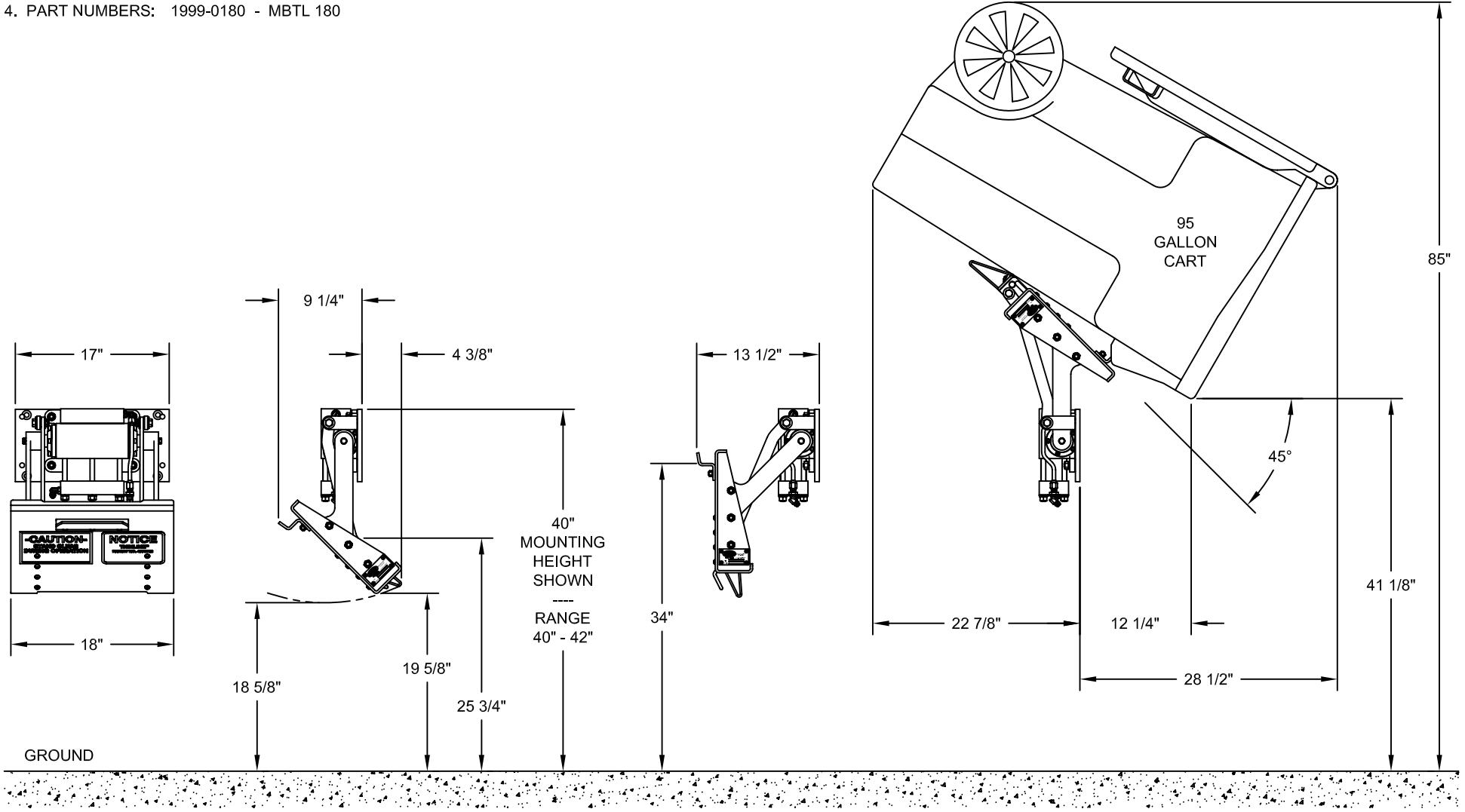

CONFIDENTIAL

THE INFORMATION CONTAINED IN THIS DRAWING IS THE SOLE PROPERTY OF BAYNE MACHINE WORKS, INC. AND IS RECALLABLE AT ANY TIME. IT MUST NOT BE COPIED OR USED DETRIMENTALLY TO THE INTEREST OF BAYNE MACHINE WORKS, INC.

UNLESS OTHERWISE SPECIFIED DIMENSIONS ARE IN INCHES
 LINEAR TOLERANCES:
 FRACTIONAL ±1/32
 TWO PLACE DECIMAL ±.015
 THREE PLACE DECIMAL ±.005
 ANGULAR TOLERANCES:
 MACHINED ±0.25 DEG
 BEND ±1.00 DEG

BAYNE MACHINE WORKS, INC.
 910 FORK SHOALS ROAD - GREENVILLE, SC 29605 - 864.288.3877

TITLE
MBTL 180 SPECIFICATIONS

MATERIAL		DRAWN BY CTT	DATE 10/20/2009	SCALE NONE	SHEET 1	OF 1
QTY	FINISH	WEIGHT	CHECKED BY	DATE	DWG NO H5700003	REV -